

HiPerFET™ Power MOSFETs

IXFB38N100Q2

$V_{DSS} = 1000\text{ V}$
 $I_{D25} = 38\text{ A}$
 $R_{DS(on)} = 0.25\ \Omega$
 $t_{rr} \leq 300\text{ ns}$

N-Channel Enhancement Mode
 Avalanche Rated, Low Q_g , Low Intrinsic R_g
 High dV/dt , Low t_{rr}

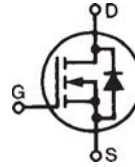

PLUS 264™ (IXFB)

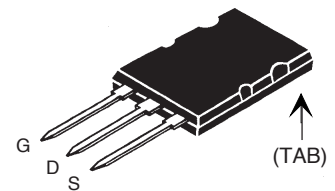

G = Gate
 S = Source
 D = Drain
 TAB = Drain

Symbol	Test Conditions	Maximum Ratings	
V_{DSS}	$T_J = 25^\circ\text{C}$ to 150°C	1000	V
V_{DGR}	$T_J = 25^\circ\text{C}$ to 150°C ; $R_{GS} = 1\text{ M}\Omega$	1000	V
V_{GS}	Continuous	± 30	V
V_{GSM}	Transient	± 40	V
I_{D25}	$T_C = 25^\circ\text{C}$	38	A
I_{DM}	$T_C = 25^\circ\text{C}$, pulse width limited by T_{JM}	152	A
I_{AR}	$T_C = 25^\circ\text{C}$	38	A
E_{AR}	$T_C = 25^\circ\text{C}$	60	mJ
E_{AS}	$T_C = 25^\circ\text{C}$	5.0	J
dv/dt	$I_S \leq I_{DM}$, $di/dt \leq 100\text{ A}/\mu\text{s}$, $V_{DD} \leq V_{DSS}$ $T_J \leq 150^\circ\text{C}$, $R_G = 2\ \Omega$	20	V/ns
P_D	$T_C = 25^\circ\text{C}$	890	W
T_J		-55 ... +150	$^\circ\text{C}$
T_{JM}		150	$^\circ\text{C}$
T_{stg}		-55 ... +150	$^\circ\text{C}$
T_L	1.6 mm (0.063 in.) from case for 10 s	300	$^\circ\text{C}$
F_c	Mounting Force	30...120/7.5...27 N/lb	
Weight		10	g

Features

- Double metal process for low gate resistance
- Unclamped Inductive Switching (UIS) rated
- Low package inductance
- easy to drive and to protect
- Fast intrinsic rectifier

Applications

- DC-DC converters
- Switched-mode and resonant-mode power supplies, >500kHz switching
- DC choppers
- Pulse generation
- Laser drivers

Advantages

- PLUS 264™ package for clip or spring mounting
- Space savings
- High power density

Symbol	Test Conditions	Characteristic Values ($T_J = 25^\circ\text{C}$ unless otherwise specified)		
		min.	typ.	max.
V_{DSS}	$V_{GS} = 0\text{ V}$, $I_D = 1\text{ mA}$	1000		V
$V_{GS(th)}$	$V_{DS} = V_{GS}$, $I_D = 8\text{ mA}$	2.5		5.5 V
I_{GSS}	$V_{GS} = \pm 30\text{ V}$, $V_{DS} = 0$			$\pm 200\text{ nA}$
I_{DSS}	$V_{DS} = V_{DSS}$ $V_{GS} = 0\text{ V}$			50 μA 3 mA
$R_{DS(on)}$	$V_{GS} = 10\text{ V}$, $I_D = 0.5 \cdot I_{D25}$ Note 1			0.25 Ω

Symbol	Test Conditions	Characteristic Values		
		(T _J = 25°C, unless otherwise specified)		
		min.	typ.	max.
g_{fs}	V _{DS} = 20 V; I _D = 0.5 • I _{D25} Note 1	24	40	S
C_{iss}	V _{GS} = 0 V, V _{DS} = 25 V, f = 1 MHz		7200	pF
C_{oss}			950	pF
C_{rss}			170	pF
t_{d(on)}	V _{GS} = 10 V, V _{DS} = 0.5 • V _{DSS} , I _D = 0.5 • I _{D25} R _G = 1 Ω (External)		25	ns
t_r			28	ns
t_{d(off)}			57	ns
t_f			15	ns
Q_{G(on)}	V _{GS} = 10 V, V _{DS} = 0.5 • V _{DSS} , I _D = 0.5 • I _{D25}		250	nC
Q_{GS}			60	nC
Q_{GD}			105	nC
R_{thJC}			0.14	K/W
R_{thCK}			0.13	K/W

Symbol	Test Conditions	Characteristic Values		
		(T _J = 25°C, unless otherwise specified)		
		min.	typ.	max.
I_S	V _{GS} = 0 V			38 A
I_{SM}	Repetitive; pulse width limited by T _{JM}			152 A
V_{SD}	I _F = I _S , V _{GS} = 0 V, Note 1			1.5 V
t_{rr}	I _F = 25A -di/dt = 100 A/μs V _R = 100 V			300 ns
Q_{RM}			1.4	μC
I_{RM}			9	A

Note: 1. Pulse test, t ≤ 300 μs, duty cycle d ≤ 2 %

PLUS 264™ Outline

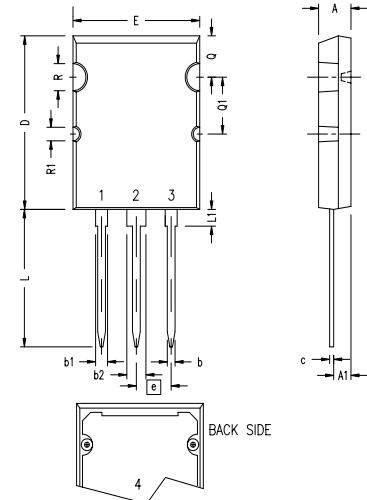

- Terminals: 1 - Gate
2 - Drain (Collector)
3 - Source (Emitter)
4 - Drain (Collector)

SYM	INCHES	
	MIN	MAX
A	.185	.209
A1	.102	.118
b	.037	.055
b1	.087	.102
b2	.110	.126
c	.017	.029
D	1.007	1.047
E	.760	.799
e	.215 BSC	
L	.779	.842
L1	.087	.102
Q	.240	.256
Q1	.330	.346
ØR	.155	.187
ØR1	.085	.093

IXYS reserves the right to change limits, test conditions, and dimensions.

IXYS MOSFETs and IGBTs are covered by one or more of the following U.S. patents:	4,835,592	4,931,844	5,049,961	5,237,481	6,162,665	6,404,065 B1	6,683,344	6,727,585
	4,850,072	5,017,508	5,063,307	5,381,025	6,259,123 B1	6,534,343	6,710,405 B2	6,759,692
	4,881,106	5,034,796	5,187,117	5,486,715	6,306,728 B1	6,583,505	6,710,463	6,771,478 B2

**Fig. 1. Output Characteristics
@ 25 Deg. C**

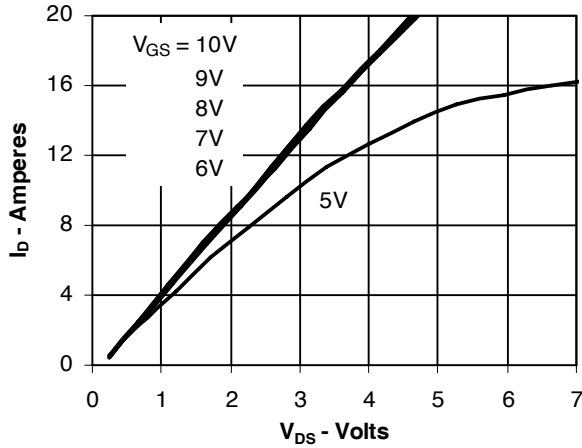

**Fig. 2. Extended Output Characteristics
@ 25 deg. C**

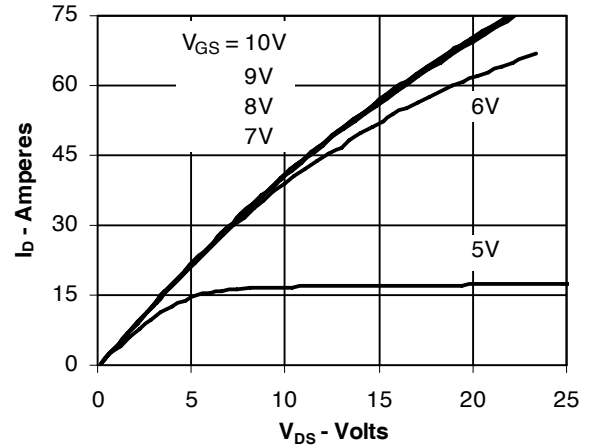

**Fig. 3. Output Characteristics
@ 125 Deg. C**

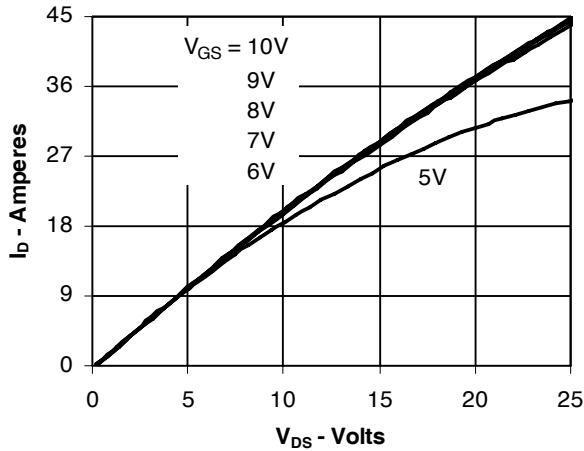

**Fig. 4. $R_{DS(on)}$ Normalized to I_{D25} Value
vs. Junction Temperature**

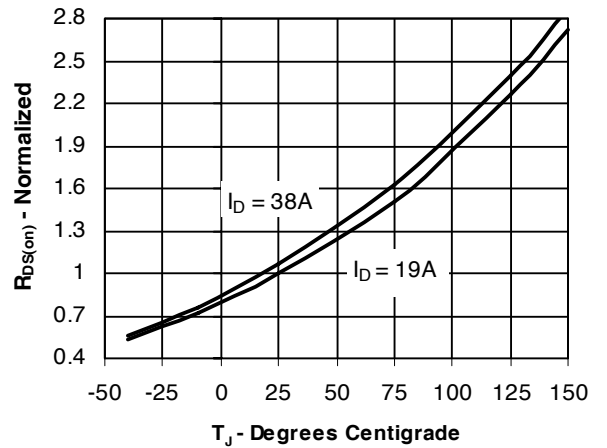

**Fig. 5. $R_{DS(on)}$ Normalized to I_{D25} Value
vs. I_D**

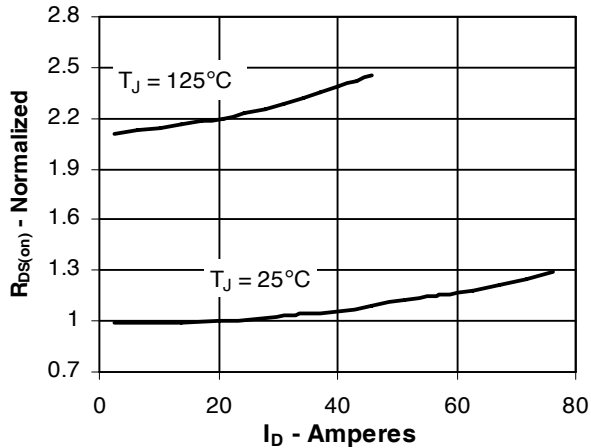

Fig. 6. Drain Current vs. Case Temperature

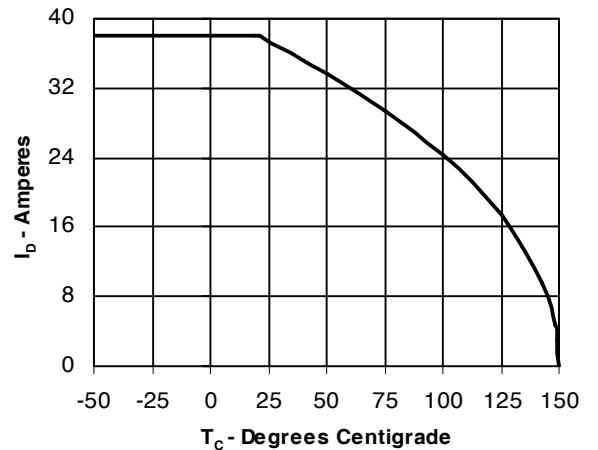

Fig. 7. Input Admittance

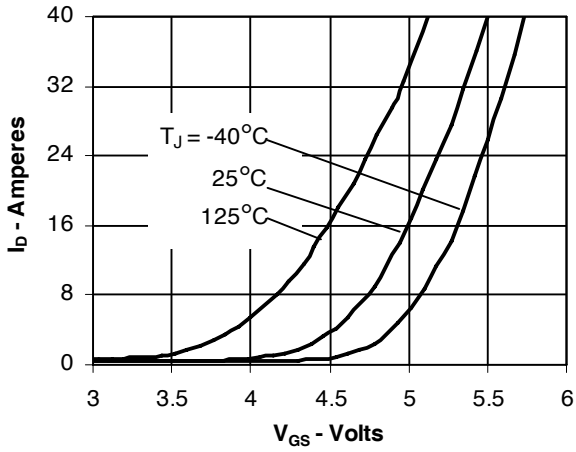

Fig. 8. Transconductance

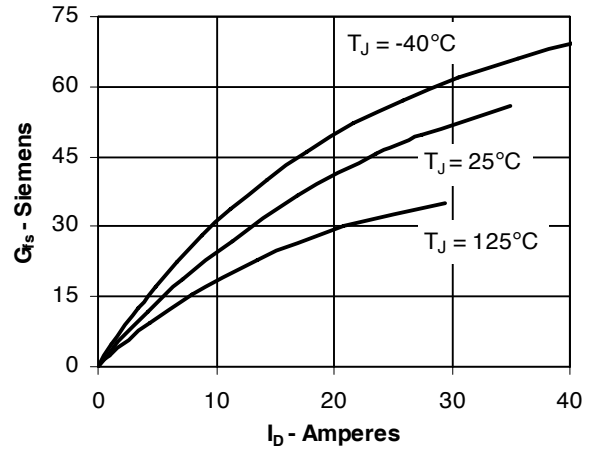

Fig. 9. Source Current vs. Source-To-Drain Voltage

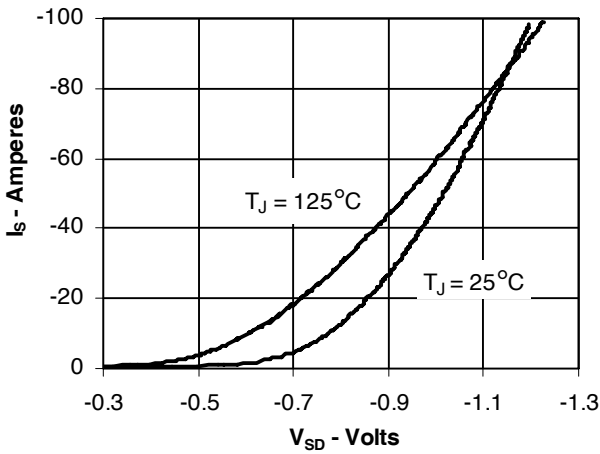

Fig. 10. Gate Charge

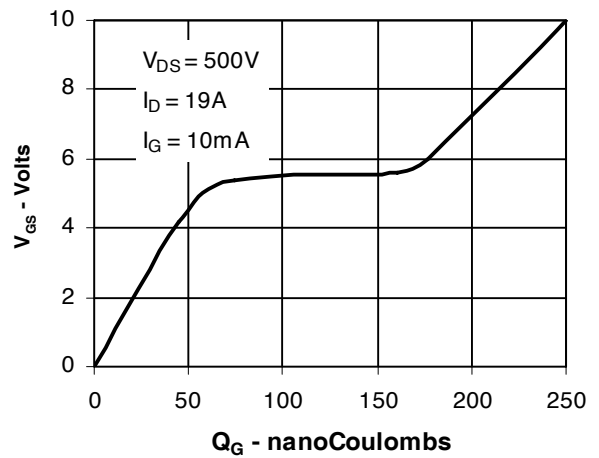

Fig. 11. Capacitance

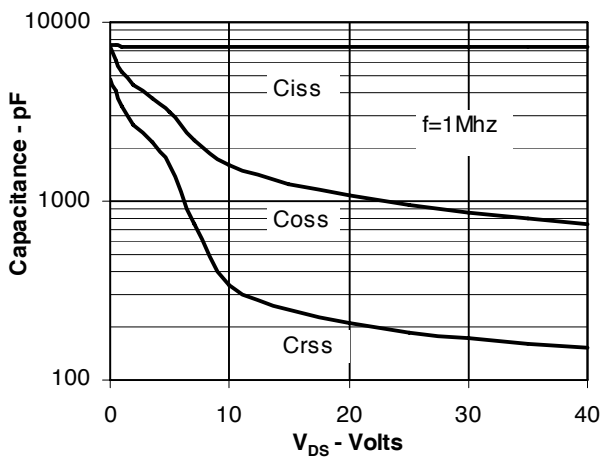

Fig. 12. Maximum Transient Thermal Resistance

